

User's Manual

PTS-G1K13M

RF Generator 1kW / 13MHz



PTS co.,Ltd.

68-1, Sangdeok-ro, Idong-myeon,
Cheoin-gu, Yongin-si, Gyeonggi-do,
#17126, Korea

Tel. 031-321-5670

Fax. 031-332-5670

Contents

- 1. Safety Precautions**
- 2. System Standard**
- 3. Dimensions**
- 4. RF Generator System Overview**
- 5. Installation**
- 6. A/D Interface**
- 7. Handy Controller (Remote Operations)**
- 8. Interlock and Alarm**
- 9. Warranty and Maintenance**

1. Precautions

Safety precautions

- Be sure you read the instructions below before using the generator.
- In case the device is damaged due to user negligence or abnormal use up on our Security Seal, it would not be guaranteed.
- Do not remove screws or open covers.
- Do not modify or replace any parts of this product.
- Do not block product ventilation port(s).
- Make sure that all cables and connectors are properly connected as indicated on the diagrams contained in this manual.

Ground the Equipment.

- To prevent electrical shock by the AC power source, please make sure that the equipment is securely connected to ground.
- If the product generates any abnormal smells or noises during use, immediately switch the power off and unplug all power cables including AC adapter from the outlet.
- Make sure power for all equipment is turned OFF before connectors are connected.
- Make sure that all cables and connectors are properly connected.

Do not operate this equipment in the potentially explosive environment.

- Do not operate the generator in area where flammable or explosive gases stored

or used.

- Do not subject to vibrations or shocks. Doing so may result in product damage or malfunction.
- Use and store in a level and stable place.

Do not touch any of the electrical components.

- It is allowed for the user to open the Case (chassis) of the generator.
- In case the user faces a problem, our internal verification is required to open the case.
- Opening the Case without written permission from us, may cause serious problems in the internal Parts product during operation. For such problems we are not responsible under any circumstances.

This equipment should not be inspected by one person only.

- Make sure that the person who operates the RF Generator is always around.

Do not change parts or modify this equipment.

- Unauthorized Parts modification or change may cause serious problems. Please contact us up on replacement or modification.

Pay attention to warnings and cautions.

All warnings and cautions mentioned in the Manual would advance warning of potential hazards to prevent accidents (see following safety symbols).

Thank you for using our RF Generator. PTS and our employees would always be there to manage customer's request. As much as possible, we will do our best to improve customer's service quality.

Safety Symbols



This symbol indicates an imminently hazardous situation such as electric shock and careless operation, which, if not avoided, will result in serious injury or worse.

It warns that there is a potential risk.



A symbol shows a care that should be taken to avoid danger or mistakes.

It tells you potential activities to reduce serious damage



This sign is physical damage due to high voltage.



It warns the product weights more than 20kg, and tells to Use Lifting Aids with Proper Lifting Techniques to ask for help.

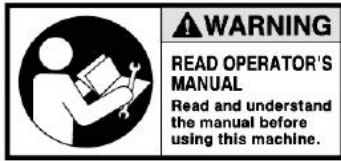

This symbol is asked to refer to the Manual for reliable equipment operation.



This symbol indicates the position where one has to connect Ground for reliable equipment operation.

2. System Standard

2-1 Basic specifications

Model	PTS-G1K13M
Output Power	0~1000W(R=50Ω Load)
Output Frequency	13.56Mhz
Output Impedance	50Ω ±2Ω
Output Connection	"N" Type Connector
Control Method	Output Power Control by CPU
Cooling Method	Water Cooling + Forced Air : (Airflow Capacity(1.5 m ³ /min) Water Volume 4L/min : Pressure Below 0.5Mpa : temperature 10~35 °C : PH 7~8 : RC3/8 NPT
Remote Terminal	Analog Control(D-sub 25pin) Device-net Control *Option
Ambient Temperature range	5~45°C
Output Method	Continuous wave
Power Supply	AC 200V ± 10% 3 φ
Size	1267 * 146 * 480mm

2-2 Output Specifications

Frequency Stability	±0.005% (5~40°C)
Output Devation	Bigger one from ±2% or 50W (25°C, 50Ω Load)
Hamonic	-45dB(below)
Output Stability	±2% (25°C, 50Ω Load)

2-3 Control Specification

The RF Generator is Analog mode and Manual Mode by which RS-232C output control is possible (on request, Device-net control would be available as optional specification).

- ① Analog Mode
Via D-sub 25 pin terminal on the back of Generator, power can be controlled through interlock confirmed by Analog Voltage.
- ② Manual Mode
Connect the Handy Controller provided on the front of the Power Control. Setting Parameters can be various to make the Interlock OK.
- ③ RS-232C Mode(Device-net option available up on selection): Power Control can be controlled via RS-232C terminal (Device-Net Selectable) on the rear of Generator.

2-4 Installation site

- ① Please maintain the ambient temperature to 5 ~ 40 °C when the generator is in operation(Power output ON)
- ② Please keep in storage area of temperature -25 ~ 55 °C when it is not under operation.
- ③ Do not install in places with high humidity, dusty, where there is a direct sunlight or places where there is any risk of water or other liquid leakage. Getting the product wet with water or other liquid may cause damage that cannot be repaired.
- ④ Use and store in a level and stable place.

2-5 Installation Requirements

- ① Fill out the front and rear of the cooling fan blower of the product smoothly.
- ② Make a space and exhaust fan from front(> 15cm), side(> 15cm), rear (> 30cm)
- ③ Set up exhaust fan in the rack more than 6m³/min.

3. Dimensions

4. RF Generator System Overview

4-1 Front Panel

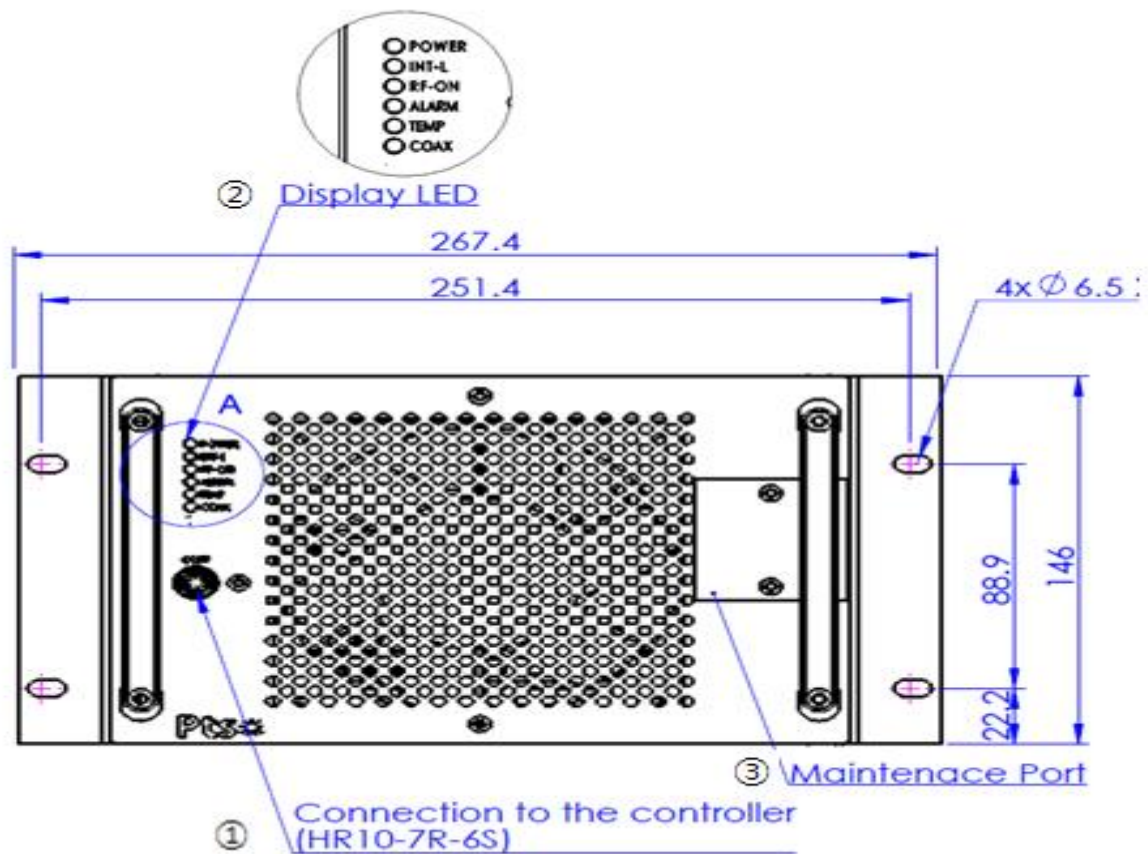

① Handy Ctrl

Connect the Handy Controller to set the operation of the Generator.

② Status Display LED

POWER It displays the main power input status. It lights when power is turned on.

INT-L External interlock light turns on when normal.

RF-ON LED Light turns on when RF-On is on.

ALARM Light turns on when there is a warning.

TEMP Light turns on when high temperature reading is there.

COAX Light up when COAX cover removed.

PLUSE

- ③ **Circuit protector** Main Switch

4-2 Rear

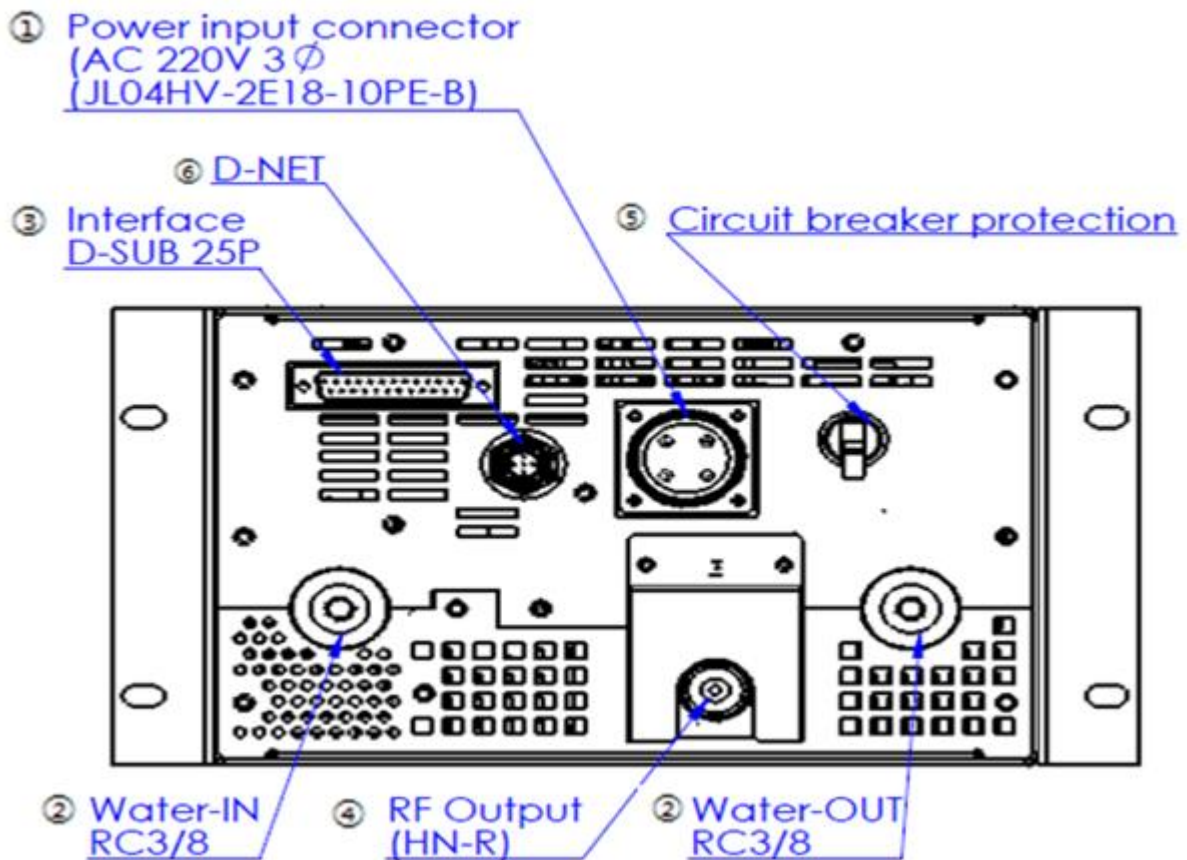

- ① **Power Input** Main power input (JL04HV-2E22-22PE-B)
- ② **Water Cooling** Water Cooling input (RC-3/8)
Water Cooling output (RC-3/8)
- ③ **Analog Interface** D - SUB connector, 25P for the A / D Interface (XM2C - 2512)
- ④ **RF output** connector ('HN' Type Female) & Connector cover
- ⑤ **Protection circuit** circuit breaker
- ⑥ **D-Net** D-Net Connector

5. Installation guide

There is a risk of electric shock. Please be careful when installing the items below.



- Before connecting AC220V, turn of the power switch and circuit breaker.
- After the power switch and the circuit breaker is OFF, connect the coaxial cable to the output terminal of the Generator.
- Make sure the cooling water is inflow before you switch on the RF power output.

5-1 Cable Connection

Power Connection

Always, turn Off power switch and circuit breaker of the power supply before connecting the RF Generator.



There is a risk of electric shock; unless you connect the power cable is connected to each phase and ground. Please check that it is properly connected.

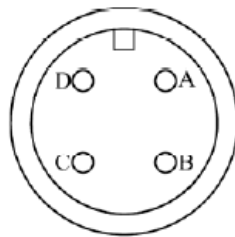

Power Plug

Pin #	Phase
A	R
B	S
C	T
D	N

RF Connection

Make sure the power is switched OFF, the Matching Unit and Generator Output is are connected using coaxial cable.

Control Connection

Analog Interface (Analog Voltage Control)

Connect a Control Signal to the Analog Interface Terminal (D-Sub 25pin)



WARNING

READ OPERATOR'S MANUAL

Read and understand the manual before using this machine.

Confirm whether interface 3-5 connected to A/D interface(Pin assignment).

6. A/D Interface (Pin Assignment)

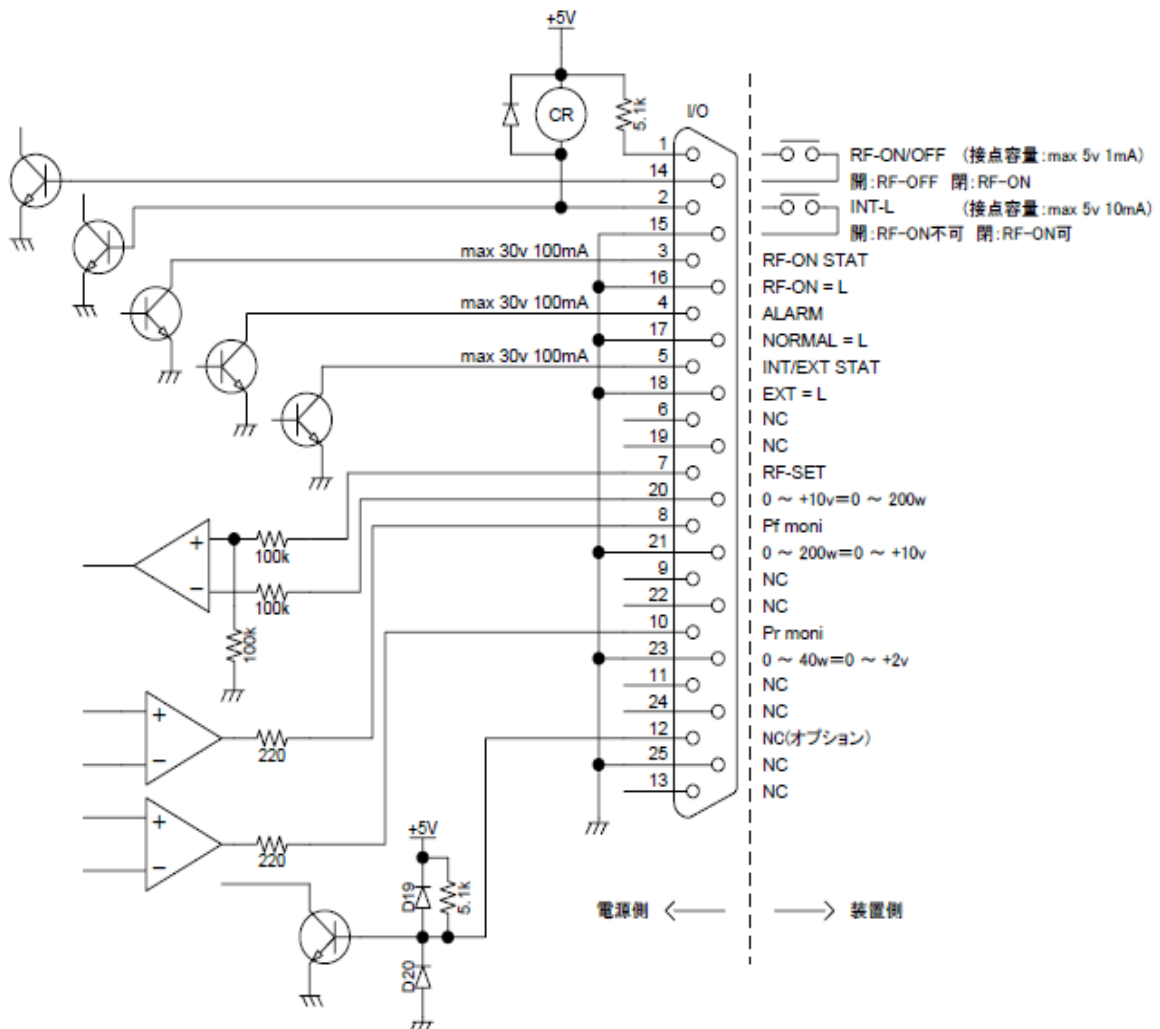

Pin No.	Name	I/O	Type	Function
1	RF-On,Off	Input	Contact	RF on/off(Max 5V 1mA)
2	INT-L	Input	Contact	Interlock(Max 5V 1mA)

3	RF On Status	output	Analog	RF on Status(Max 30V 100mA)
4	ALARM	Output	Analog	ALARM(Max 30V 100mA)
5	INT/EXT STAT	Output	Analog	INT/EXT Status(Max 30V 100mA)
6	NC			
7	RF Set	Input	Analog	RF Set Voltage(0~+10V=0~1000W)
8	Pf moni	Output	Analog	FWD Monitoring Voltage(0~+10V=0~1000W)
9	NC			
10	Pr moni	Output	Analog	REF Monitoring Voltage(0~10V=0~1000W)
11	NC			
12	NC			
13	NC			
14	D-GND	Input	Contact	RF-On Return
15	A-GND	Input	Contact	Interlock Return
16	A-GND	Output	Analog	RF-On Status Return
17	A-GND	Output	Analog	ALARM Return
18	A-GND	Output	Analog	Int/Ext Status Return
19	NC			
20	A-GND	Input	Analog	RF-Set Return
21	A-GND	Output	Analog	FWD Monitor Return
22	NC			
23	A-GND	Output	Analog	REF Monitor Return
24	NC			
25	NC			

※ Please use D-GND and remove A-GND.

Analog Interface Connector Pin Functions

① RF On/Off (RF power On/Off Signal)

Pin 1,14 Open while RF off, and Close while RF On

② INT-L (Interlock Signal)

Pin 2,15 Open if no RF power, Close if there is RF power

- ③ RF On Status (RF Power Output Signal)
Pin 3,16 Open when the generator is in Idle, Close when RF Power is applied/RF power on state /
- ④ ALARM (Generator internal Alarm Signal)
Pin 4,17 Open when normal. Close when internal problem occurs
- ⑤ INT/EXT Status (INT / EXT Signal state)
- ⑥ RF Set (RF Power Set voltage)

Pin 7 (Set RF)) to a 0 ~ 10V, RF Output Power Set 0 ~ 3,000W to 20 (A - GND).

- ⑦ Pf Moni(FWD Power Monitor)

7. Handy Controller

7-1 Handy Controller



Keep in mind that incorrect operation of Handy Controller may a cause problem.

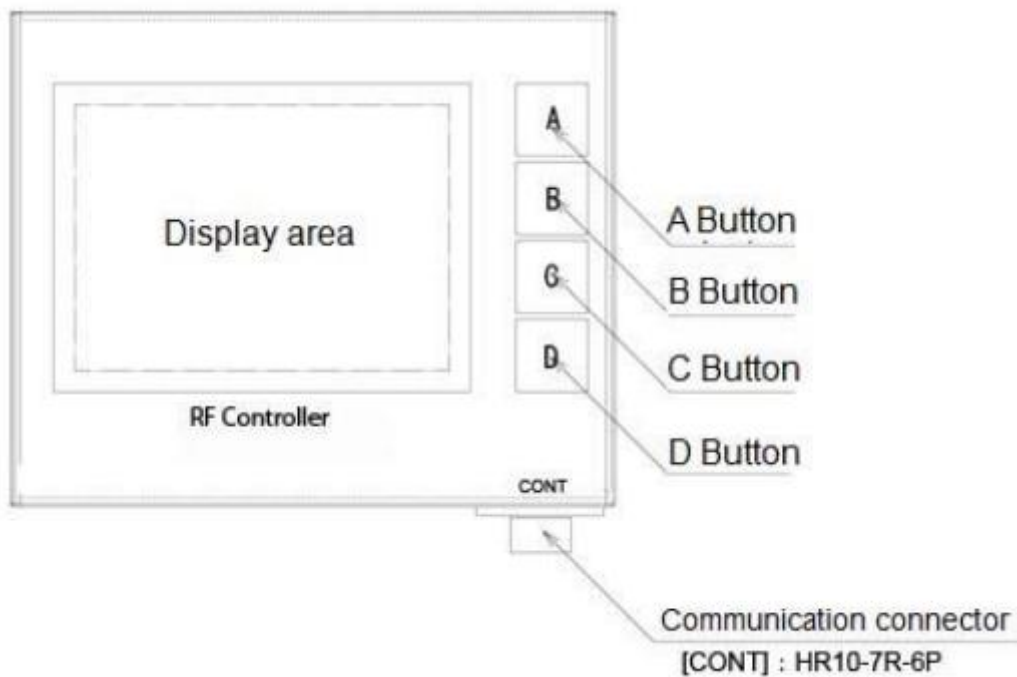

- Display Area Liquid crystal display (W 62.0 × H 44.0), Resolution 128 × 64
- Buttons A-D Buttons and mini tact switch are used. Key top is a panel sheet film. Software determines operational functions.
- Communication connector CONT: HR10-7R-6P – Connects with Matching Box CONT connector.

Operating Method

Status Display: The entry of the generator control signal or display monitor.

Button Function: Pressing A-D Buttons performs the function displayed next to the corresponding button. Functions correspond to A-D Buttons from top to bottom.

	Status Display	Button Function
RF Output Monitor	SET POWER RF : OFF PF PR 0.00 ^k 0 _w	--
		--
Status Display	MD RS232 CW SETPF 0.00 ^k _w	--
		FUNC

EXT : maintenance Mode (Analog I/O Control).

INT : Internal Control State.

RS232 : Communication Control

Control System

Caution! : Don't change the settings while RF-ON

SET POWER^{※1} is displayed when you press D button [FUNC]^{※2} (it goes to power SETUP Screen)

①	SET POWER	RF : OFF	---
	PF	PR	---
	000 _w ^k	0 _w	---
	MD RS232 CW		---
	SETPF		
	000 _w ^k		FUNC ②

※1 ①

※2 ②

SET POWER 화면

In the function setting screen select [OPERATE]^{※3} to move to [Operate] Screen

①	FUNCTION	RF : OFF	↑
	OPERATE		↓
	SLOWUP		ENT
			QUIT

※3 ①

FUNCTION 화면

From [OPERATE Screen]^{※4}, move the underscore to the item you want to select by pressing [QUIT]^{※5} (D Button).

①	OPERATE	↑
	OPERATE EXT	↓
	INT	---
	RS232	
		QUIT ②

※4 ①

※5 ②

OPERATE 화면

※6 Confirm Screen

OPERATE	↑
OPERATE EXT	
OPERATE MODE INT	
A (YES) OR B (NO)	
	QUIT

Slow up time

Slow up settings to set up communication with the AC power during the initial values.

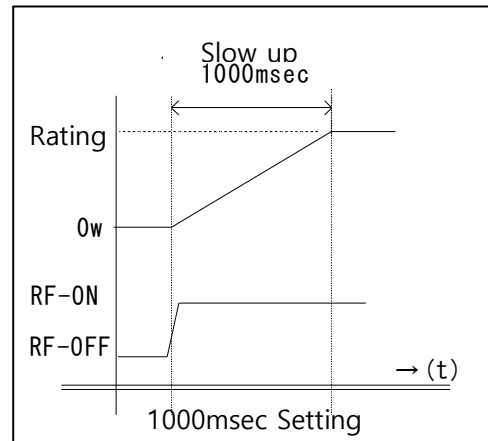

In the function setting screen, by selecting the [SLOWUP Screen] ※ 7 to move to [Slow up setup screen].

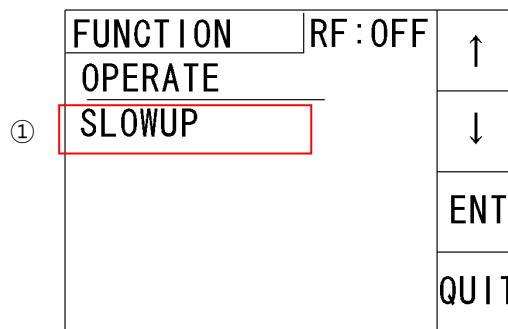

Function Setting Screen

Slow up, down setting , can be operated using A button [↑] and B button [↓] ※ 8.

↑ : Press once to increase the setting to 50

↓ : Press once to decrease the setting to 50

(It is set in the range of 300msec ~ 5000msec)

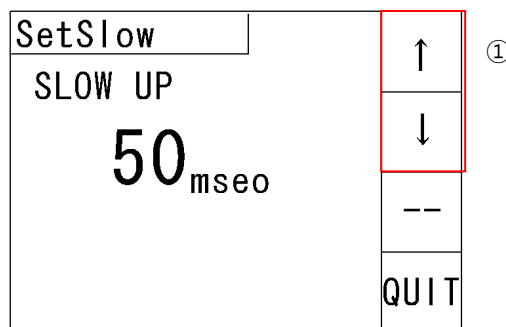

Slow up, down Setting Screen

After setup is completed, it can be set by pressing the [QUIT] (D button). (A

confirmation screen is displayed.) Setting value is stored as the initial value of the equipment.

Internal Control during Operation

RF Output Method

From USET POWER screen, by pressing the Internal control button [OUTPUT] ※ 9. The RF output confirmation screen is displayed.

SET POWER	RF:OFF	OUT PUT ①
PF	PR	PF ↑
0.00 ^k _w	0 _w	
MD RS232 CW		PF ↓
SETPF		FUNC
0.00 ^k _w		

SET POWER Screen

※9 ①

※ Confirmation screen

SET POWER	RF:OFF	OUT PUT
SET		
CHANGE TO RF ON A (YES) OR B (NO)		
P	w	
PR	0 _w	FUNC
	U _w	FUNC

How to set the output power

RF power setting operation of the B button [PF ↑ U] ※ 10 and D button [PF ↓] ※ 11 .

↑ : Pressing once increases the value by 1 .

↓ : Pressing once decreases the value by 1.

(This change will be effective as you press and hold).

SET POWER	RF:OFF	OUT PUT
PF	PR	PF
0.00 ^k _w	0 _w	↑
MD RS232 CW		PF
SETPF		↓
0.00 ^k _w		FUNC

※10 ①

※11 ②

Alarm Confirmation

The error status on alarm confirmation screen of the RF power can be checked. If an error occurs, error checking screen is displayed.

ViewERROR 0x40CF	--
INT-L OPEN	--
TEMP ERR	--
COVER ERR	--
PR TRIP	--
	QUIT

Error confirmation screen

8. Interlock and Alarm

Its function is to protect the generator, or to avoid a hazard. If there is risk of accidents and serious damage to the product, stop working. If you cannot turn off Interlock please contact us.

8-1 RF Power Output of Alarm

Temp Err

The error is generated when the internal temperature rises and Temp sensor fail. Check water flow and air flow around the rear of the generator and start again.

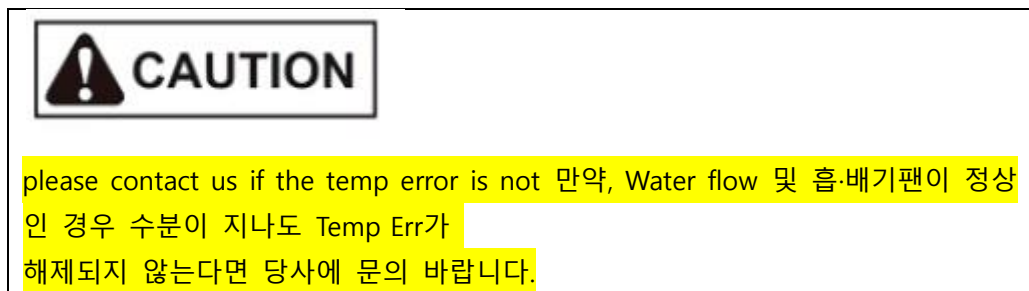

Cover Err

While generator is under operation, if the Cover or Coaxial Cable Cover is removed , it could cause an accident caused by a high voltage. Make sure the connection of the coaxial cable.

Amp Err

This error occurs due to parts in the amplifier. If the error cannot be reset contact our company.

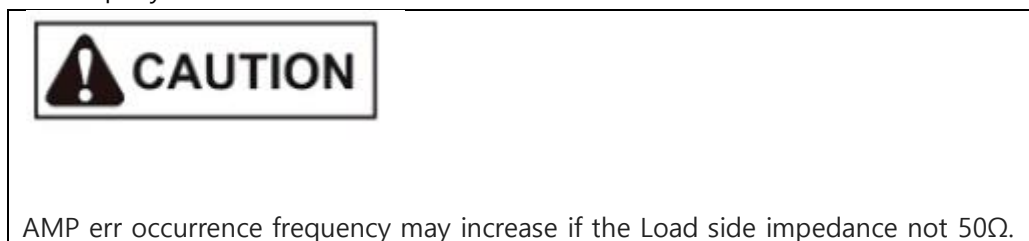

PR Trip



If PR Trip is generated a continuously, check whether coaxial cable is normal or not and, contact us. When the product burns on the issues our Company will not take responsible.

INT-L

It occurs if the equipment-side Interlock occurrence or Analog Interface INT-L is Open,.

8-2 Reflected Power Control

The RF generator has a built in functionality to protect against Reflect Power.

8-3 Maximum Output Control

The RF Generator has embedded functions to control the maximum output.

Please refer Handy Controller usage.

8-4 Slow Up, Down

본 Generator는 안정적인 플라즈마 형성을 위하여 설정 Power까지 도달하는 시간을 지정할 수 있습니다. 사용자 설정에 의하여 300~500msec까지 설정 가능하며, 설정시 Set Power까지 Forward Power가 도달하는 시간이 선형적으로 변경됩니다.(Slow Down은 Option사양이므로 당사 문의 바랍니다.)

8-5 Arc Cut

본 Generator는 Arc 발생시 출력 Power를 제어하는 기능이 내장되어 있습니다. Arc발생시 2usec이내에 감지하여 출력 Power를 Off하고 약 10usec후 재출력합니다. 감도는 정격출력의 0~100%까지 지정 가능하며, Ramp up후 활성화되기 때문에 Reflect Power에 의해 오동작을 하지 않습니다.

9. Maintenance and Warranty

The warranty period of this product will be for one year from time of delivery. Issues occurring within the warranty period due to manufacturing defects will be repaired free of charge. This warranty is only applicable to products delivered in South Korea. Additionally; repairs for failures due to the following will be require payment for service from the customer even within the warranty period:

10-1 Cases of Warranty Exclusion

- Wearing out of consumable parts
- Improper handling by the customer
- Use outside of prescribed usage environment ranges
- User modifications
- Natural disasters or accidents causing damage to the unit including but not limited to fire, water leaks, and dropping of the product